



VALLONE

ADD/BLACK

AB 04-60

1800.70.04.MB.60

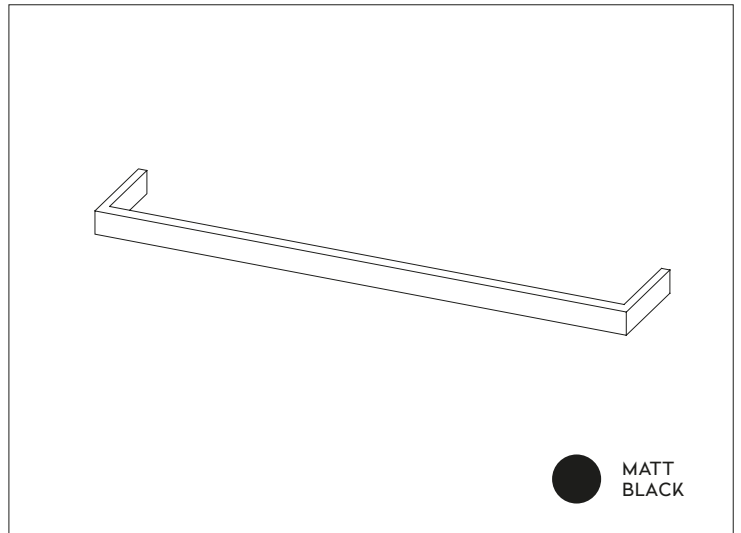

TECHNICAL FILE

SINGLE TOWEL BAR – STAINLESS STEEL (MATT BLACK COATED), 60 CM

TECHNICAL DRAWING (MEASUREMENTS IN MM)

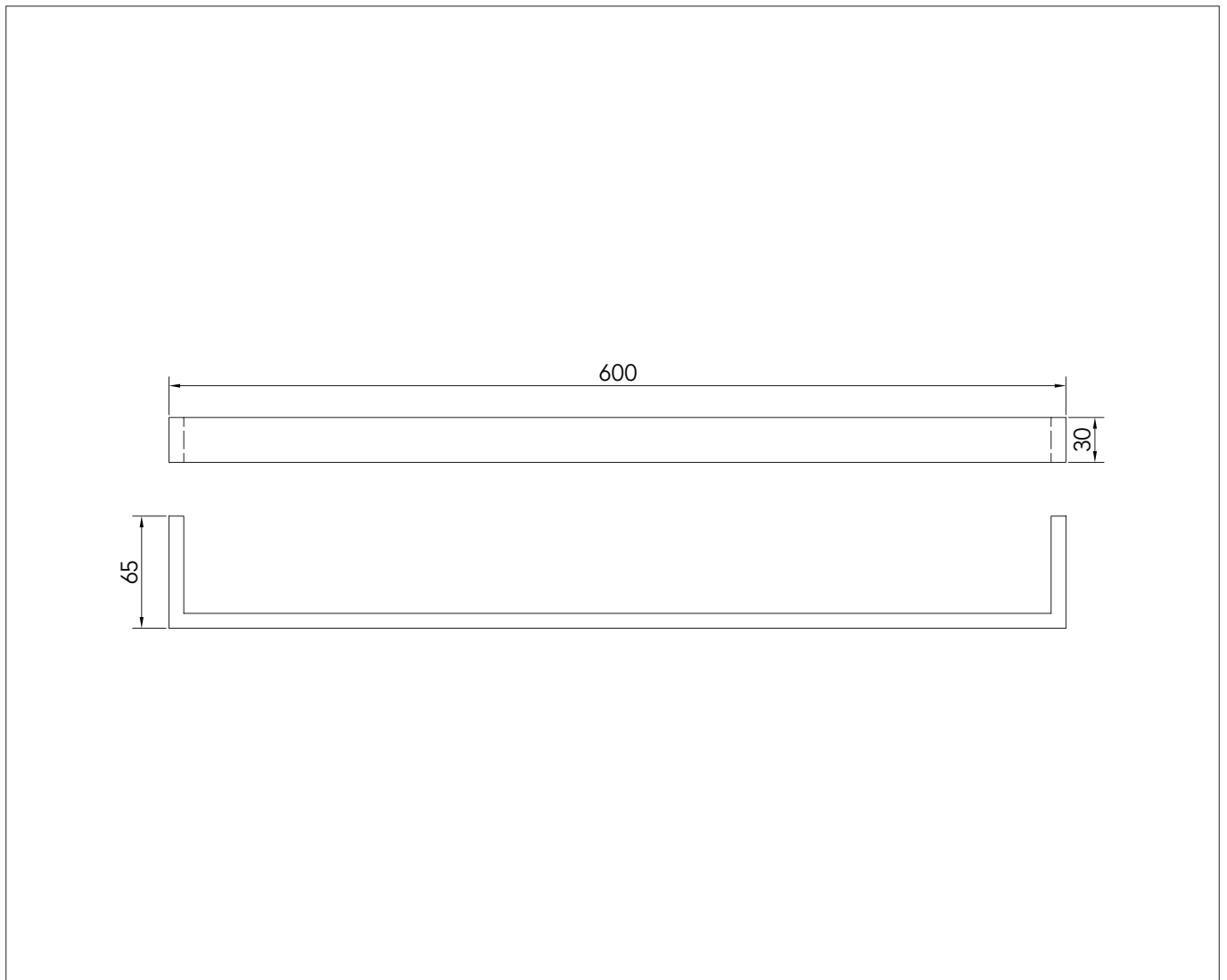

TECHNICAL FILE

INSTALLATION INTRODUCTIONS

FOR INSTALLATION FOLLOW
THE INDICATIONS OF THE DRAWING

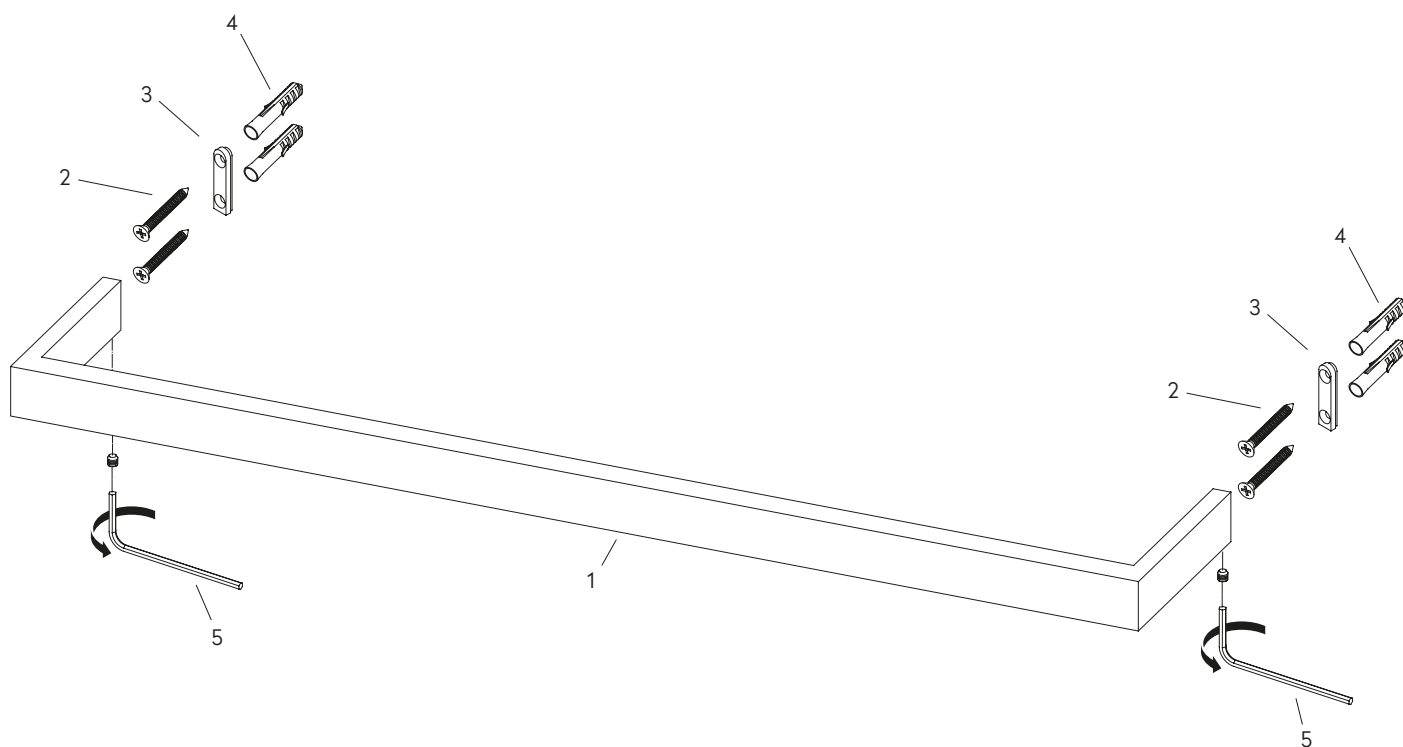

TECHNICAL DATA

N°	DESCRIPTION
01	TOWEL BAR
02	SCREW
03	FIXATION BUSH
04	PLUG
05	ALLEN KEY

INSTALLATION RECOMMENDATIONS

The accessories should be applied after the end of the work, namely after paintings and treatment/varnishing of the wood. The use of acidic or containing solvents substances for cleaning floors or other parts of the building should not be made after the application of the accessories, because the vaporization of these products can cause damage. Check that there are no buried pipes or cables before drilling holes.

CLEANING AND MAINTENANCE

Cleaning must be done with liquid soap and water. Do not use liquid detergents containing abrasive or acidic substances, abrasive sponges or disinfectants. Incorrect cleaning may permanently ruin the surface of taps. On color finishings, do not use products containing alcohol, acetone and other solvents.